

MAXIM

MAX1425 Evaluation Kit

General Description

The MAX1425 evaluation kit (EV kit) is an assembled and tested board for prototyping designs using the MAX1425 or MAX1426 analog-to-digital converters (ADCs). The board interfaces to a user-provided logic analyzer or data-acquisition system. An external clock generator and +5V power supply are required.

Features

- ◆ 20MSPS Conversion Rate
- ◆ Clock Shaping Circuit
- ◆ On-Board TTL Buffers
- ◆ Wideband Transformer Accepts Single-Ended Input
- ◆ Fully Assembled and Tested

Ordering Information

PART	TEMP. RANGE	IC PACKAGE
MAX1425EVKIT	-40°C to +85°C	28 SSOP

Component List

DESIGNATION	QTY	DESCRIPTION
C1, C4–C8, C15, C16, C20, C22, C25, C27, C30, C34, C35, C37	16	0.1µF ceramic capacitors (0805)
C2, C10	2	100pF ceramic capacitors (0805)
C3, C9	2	22pF ceramic capacitors (0805)
C11, C17, C18, C21, C26, C28, C29, C31, C32, C33	10	2.2µF, 10V capacitors Sprague 595D "A" case size
C12, C13, C14, C23	4	100µF, 25V capacitors Sprague 595D "R" case size
J1	1	2x10-pin header
REF IN, IN1, CLK IN	3	SMA connectors
JU1	1	2-pin header
JU2	1	3-pin header
R1	1	2kΩ ±5% resistor (0805)
R2, R3, R35, R38	4	100Ω ±5% resistors (0805)

DESIGNATION	QTY	DESCRIPTION
R4, R5	2	25Ω ±5% resistors (1206)
R6, R7, R8	3	51Ω ±5% resistors (1206)
R9	1	2.5kΩ ±5% resistor (1206)
R10	1	2.5kΩ ±5% resistor (0805)
R11	1	1kΩ ±5% resistor (0805)
R12	1	4kΩ ±5% resistor (0805)
R13–R33	21	200Ω ±5% resistors (0805)
R34	1	2kΩ potentiometer
R36	1	3kΩ ±5% resistor (0805)
R37	1	100Ω ±5% resistor (1206)
T1	1	Transformer Minicircuits T1-1T-KK81
U1	1	Maxim MAX1425EAI
U2, U3	2	74ALS541A
U4	1	Maxim MAX473ACSA
U5	1	Maxim MAX961CSA

Evaluates: MAX1425/MAX1426

MAX1425 Evaluation Kit

Quick Start

You'll need the following required equipment:

- DC power supplies: 2 each (use for digital +5V and analog +5V)
- Function generator for clock input, 2Vp-p
- Function generator for signal input, 2Vp-p
- Logic analyzer or data-acquisition system
- Voltage reference (optional)

Note: To ensure maximum performance, use a clock generator with low phase noise, such as the HP 8662A filtered with an appropriate bandpass filter.

The MAX1425 EV kit is fully assembled and tested. Follow these steps to verify board operation. **Do not turn on the power supply until all connections are complete.**

- 1) Connect one +5V DC power supply to +5VA and +5VADUT. Connect the negative terminal of this supply to AGND. Connect the second +5V supply to +5VDDUT and +5VD. Connect the negative terminal of the second supply to DGND. See Table 1.
- 2) If using an external reference, connect a 2.500V \pm 1mV voltage reference to the REF IN connector. If using the internal reference, do not connect anything to the REF IN connector.
- 3) Connect a 20MHz, 1Vp-p clock function generator to the CLK IN connector.
- 4) Connect the signal function generator to the IN1 connector.
- 5) Connect a logic analyzer (e.g. HP16500C) or data-acquisition system to header J1. Configure jumpers JU1 and JU2 as shown in Table 2.
- 6) Turn on the power supplies and reference supply (if used).
- 7) Enable the function generators. Adjust potentiometer R34 so that the strobe signal has 50% duty cycle.
- 8) Begin acquiring digital data.

Detailed Description of the Hardware

The MAX1425 EV kit is a proven PC board layout pattern that gives good analog performance. Refer to the MAX1425 data sheet for more information.

The clock signal from the CLK IN connector is terminated by R35/R38 and AC-coupled by C16 into U5, the MAX961 comparator. Potentiometer R34 sets the clock threshold. Comparator U5 produces a square-wave output, driving the MAX1425 and providing a clock output (J1-20) to be

used with a user-supplied data-acquisition system. Jumper JU2 selects the polarity of the J1 strobe signal.

The analog input signal from the IN1 connector is terminated by R2/R3 and coupled through transformer T1. The transformer converts the single-ended input into a differential signal between VINP and VINN, with common-mode voltage set by the CML pin and buffered by U4.

The device under test, U1, samples analog input VINP-VINN. Its digital outputs are buffered by U2 and U3 (74ALS541). The twenty 200 Ω series resistors help isolate the A/D converter from switching transients. The buffered digital outputs appear on connector J1.

Performance Considerations

Careful attention to setup and testing is necessary to achieve optimum results with this high-performance converter. Precise and accurate phase-locked signal sources should be employed in all cases. Low jitter sources, such as the HP 8664B for the input phase-locked with a second low-jitter clock generator, will give the best results. In addition, lowpass or bandpass filters should be used on the input signal to ensure that the MAX1425's low-distortion characteristics are maintained.

Table 1. Power Connections

TERMINAL	FUNCTION
+5VA	Analog Supply to the Signal Conditioning Op Amps
+5VADUT	Analog Supply to the Device Under Test
AGND	Analog Ground Return
DGND	Digital Ground Return
+5VDDUT	Digital Supply to the Device Under Test
+5VD	Digital Supply to the Digital Buffers

Table 2. Jumper Settings

JUMPER	SETTING	FUNCTION
JU1	Open	Output Enable = low (enabled)
	Closed	Output Enable = high (disabled)
JU2	1-2 (bottom position)	STROBEIN polarity is the same as CLK
	2-3 (top position)	STROBEIN polarity is the opposite of CLK

MAX1425 Evaluation Kit

Evaluates: MAX1425/MAX1426

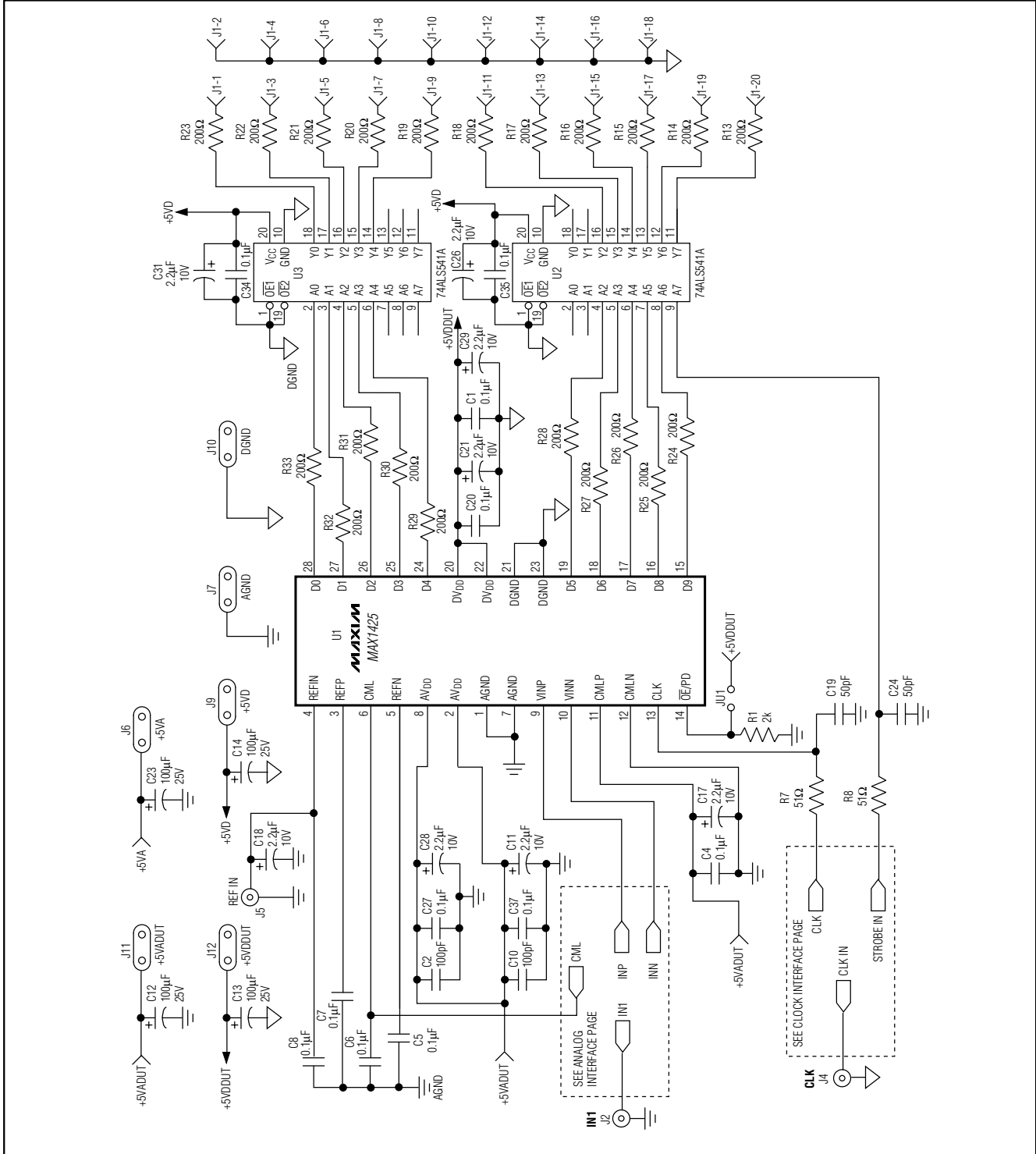

Figure 1. MAX1425 EV Kit Schematic

MAX1425 Evaluation Kit

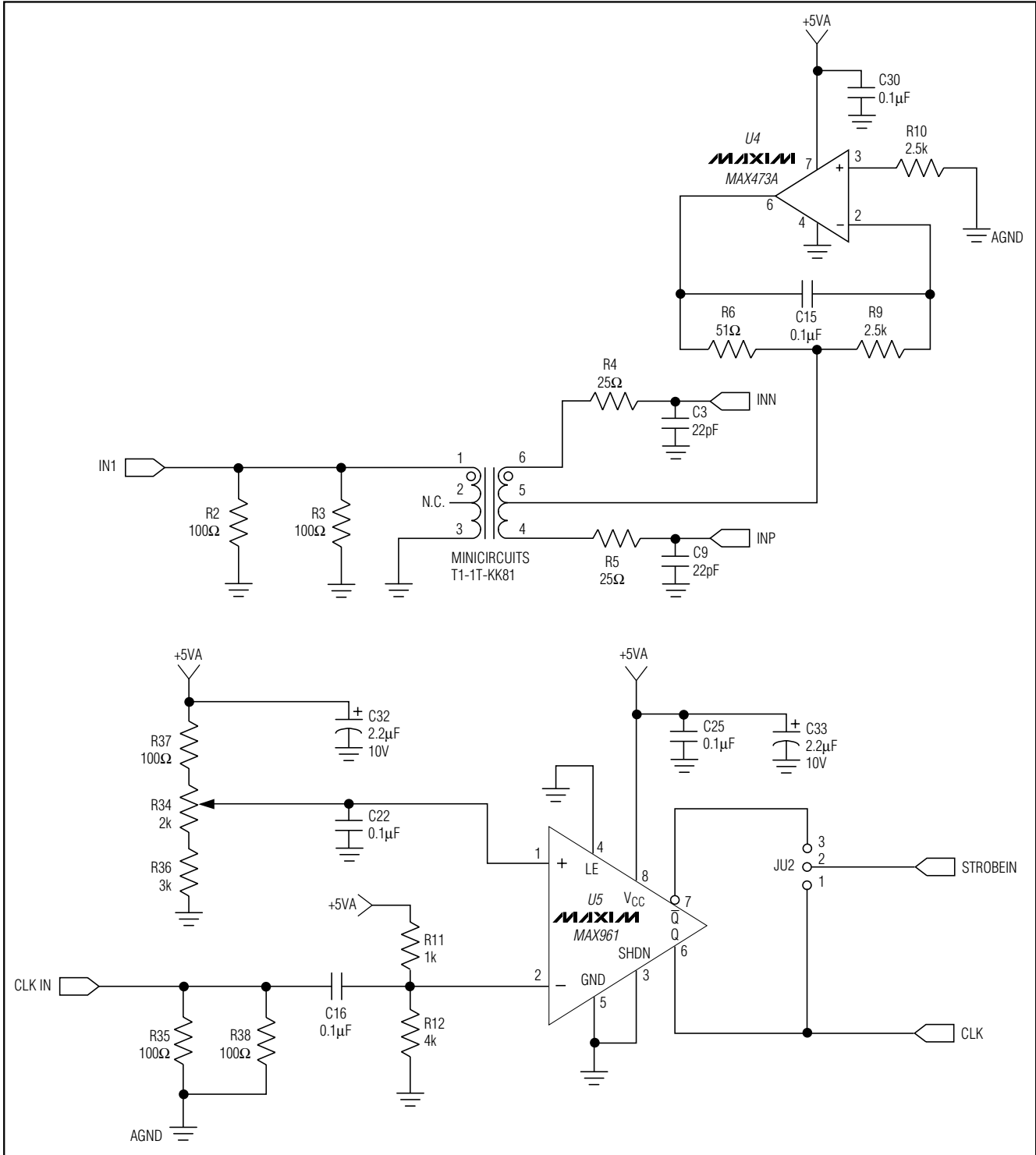

Figure 1. MAX1425 EV Kit Schematic (continued)

MAX1425 Evaluation Kit

Evaluates: MAX1425/MAX1426

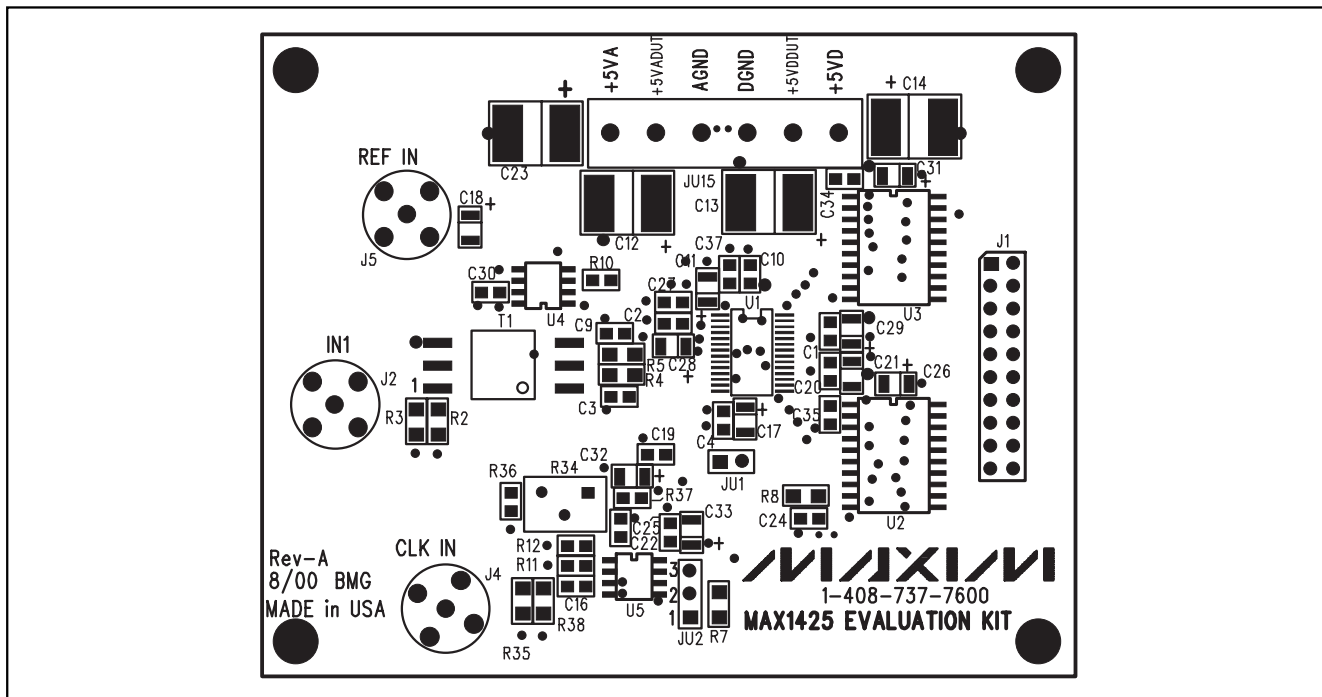

Figure 2. MAX1425 EV Kit Component Placement Guide—Component Side

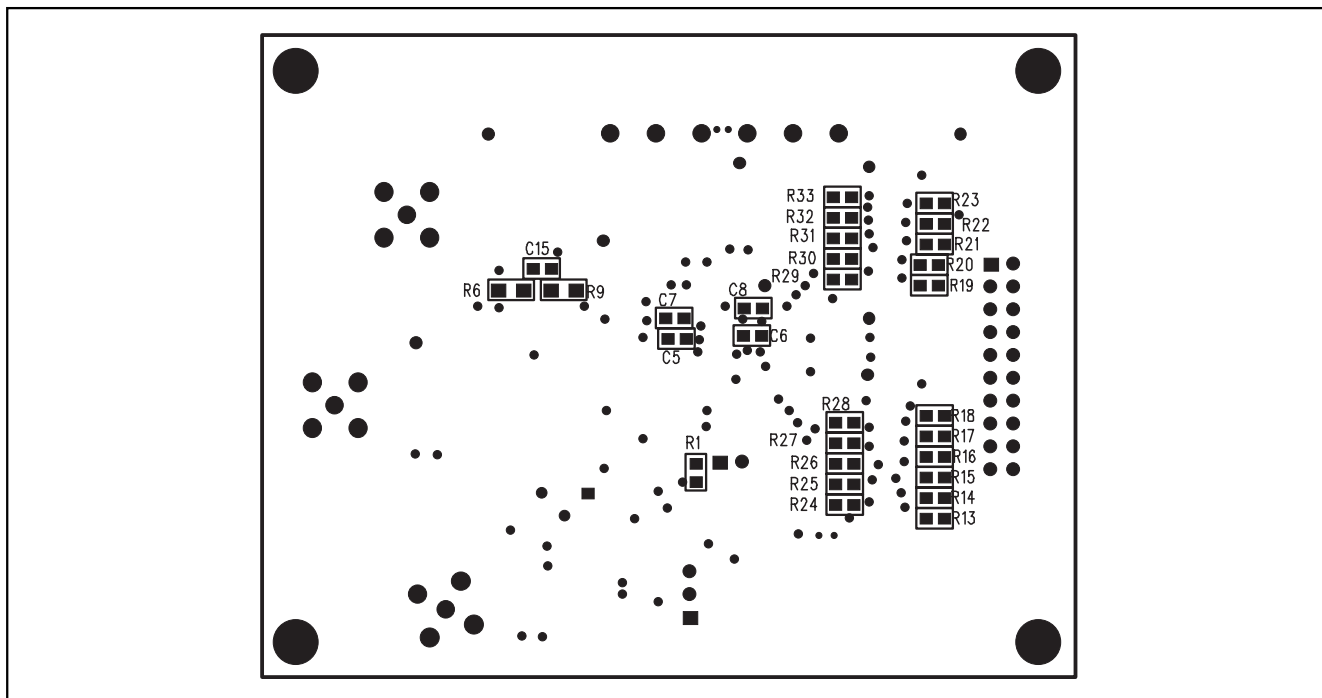

Figure 3. MAX1425 EV Kit Component Placement Guide—Reverse Side

MAX1425 Evaluation Kit

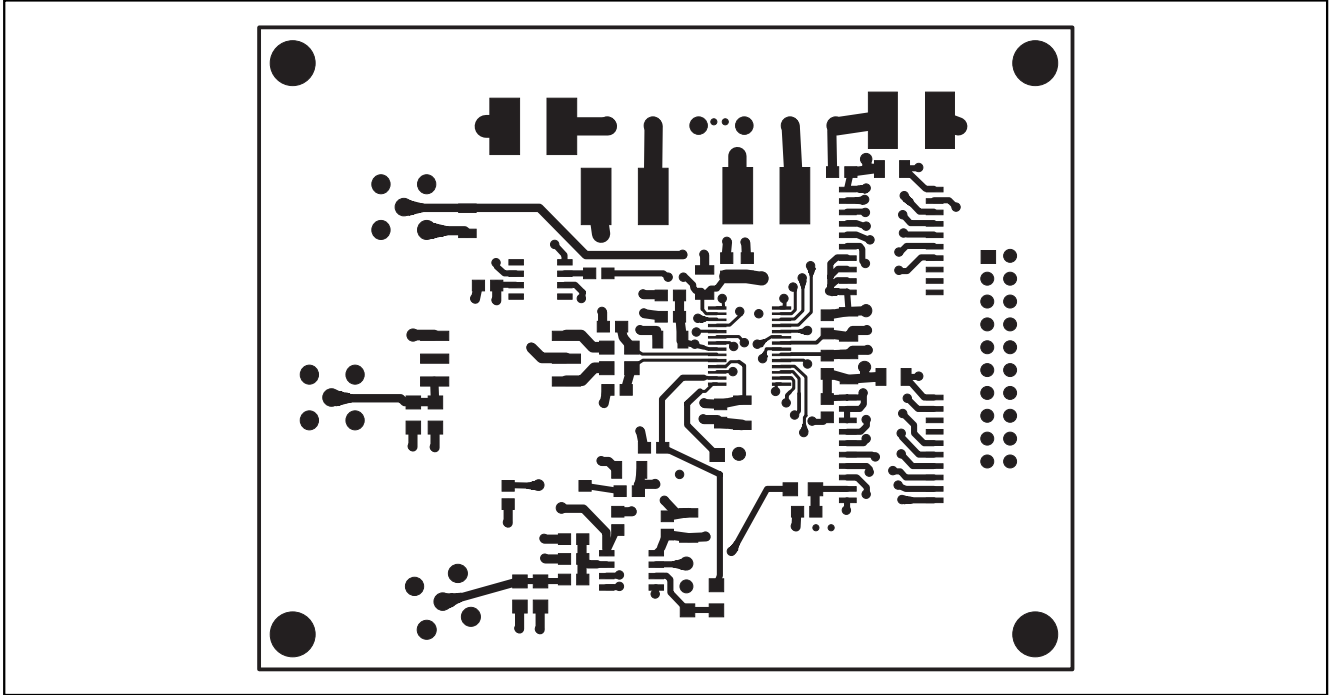

Figure 4. MAX1425 EV Kit PC Board Layout—Layer 1

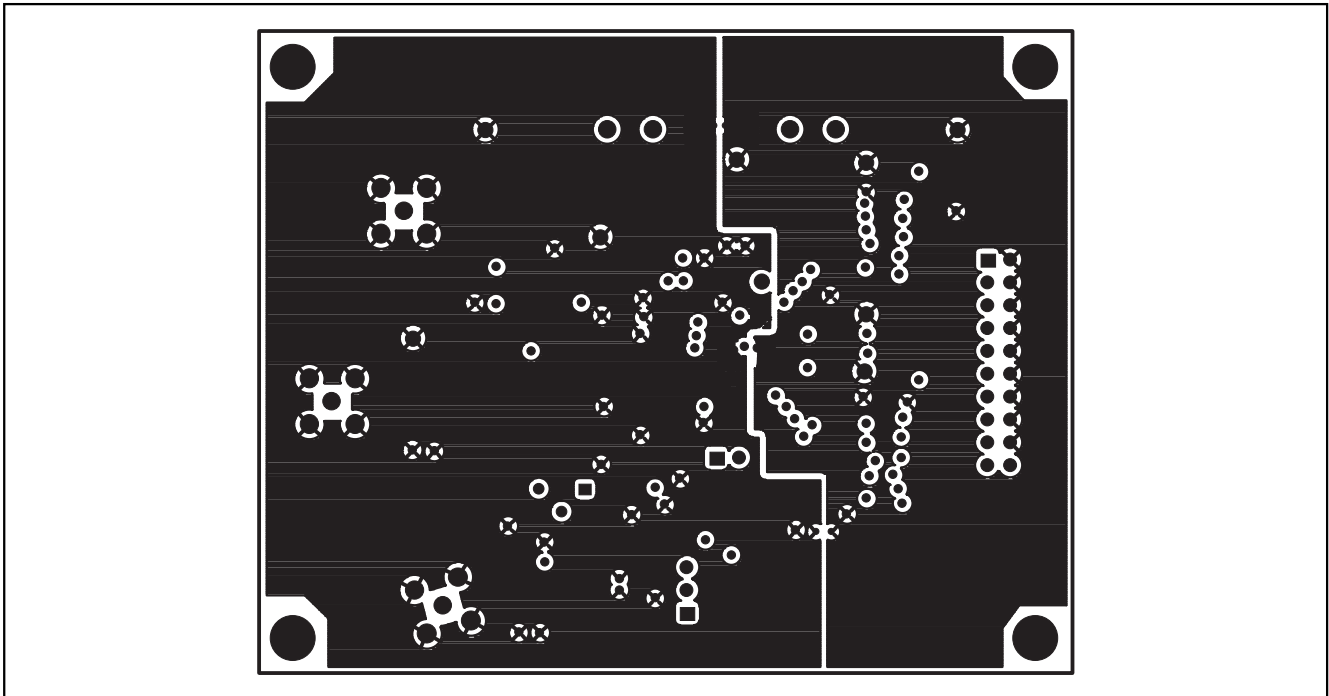

Figure 5. MAX1425 EV Kit PC Board Layout—Layer 2

MAX1425 Evaluation Kit

Evaluates: MAX1425/MAX1426

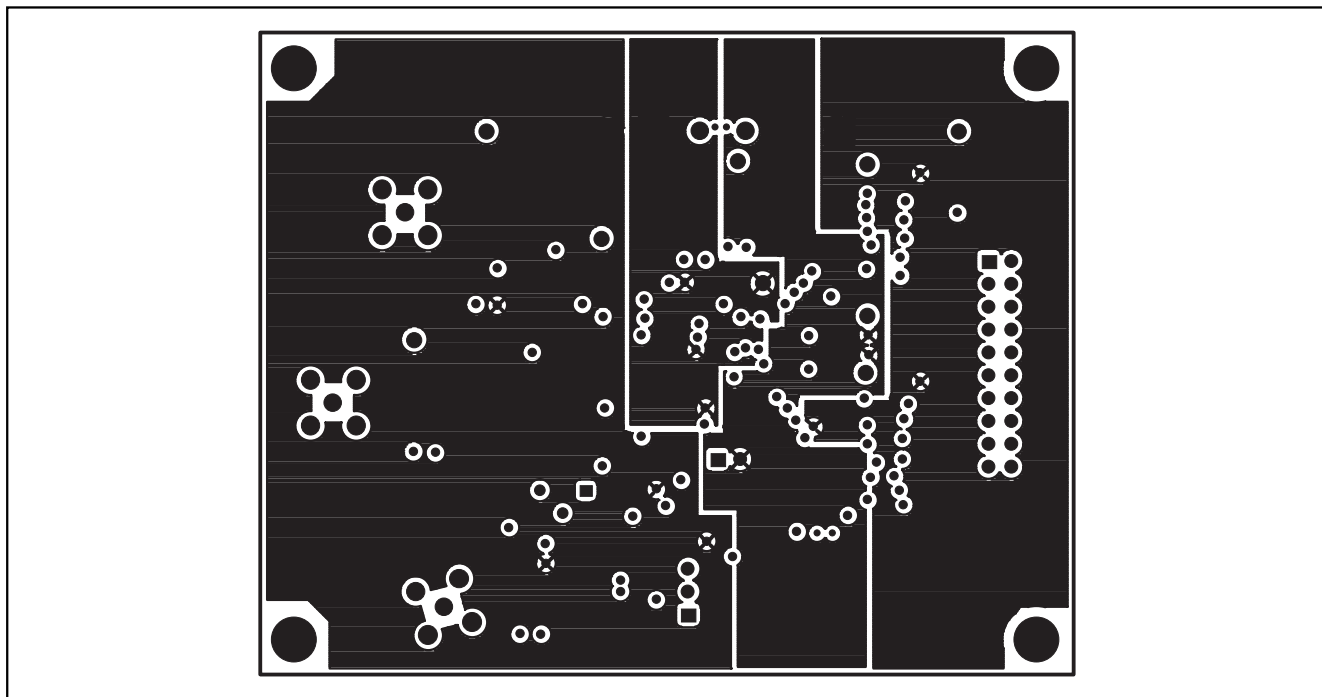

Figure 6. MAX1425 EV Kit PC Board Layout—Layer 3

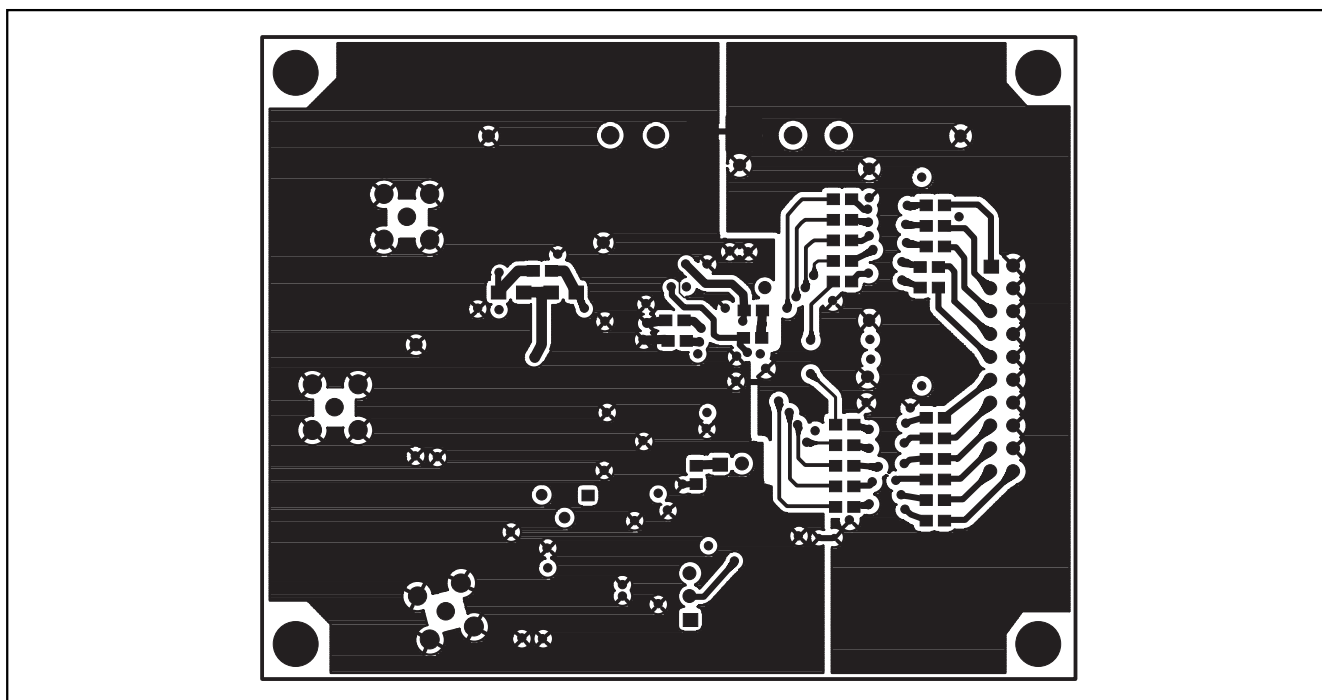

Figure 7. MAX1425 EV Kit PC Board Layout—Layer 4

Maxim cannot assume responsibility for use of any circuitry other than circuitry entirely embodied in a Maxim product. No circuit patent licenses are implied. Maxim reserves the right to change the circuitry and specifications without notice at any time.

7 **Maxim Integrated Products, 120 San Gabriel Drive, Sunnyvale, CA 94086 408-737-7600**